

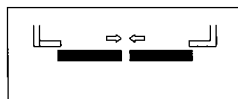

PORTE AUTOMATICHE
PER ASCENSORI
AUTOMATIC DOORS
FOR ELEVATORS

LINEAR D.O.S. MINI SILL

PAGE



C2C

02 - 05

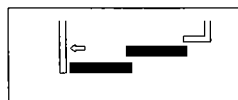

C2S

06 - 10



C4C

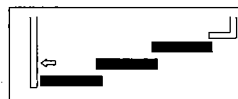

C3S

11 - 14

PRISMA S.R.L

QUARTIERE ARTIGIANALE

I-43055 CASALE DI MEZZANI (PR) ITALY

TEL. +39 0521 3164 11

TEL. +39 0521 3164.333

E-MAIL: SALES@PRISMAITALY.IT

WWW.PRISMAITALY.IT

PRODUCTION UNIT:

1) PESSANO CON BORNAGO (MI) ITALY

2) CASALE DI MEZZANI (PR) ITALY

CE

INSTALLATION LAYOUT

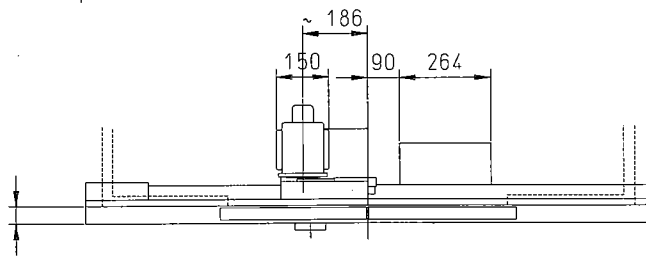
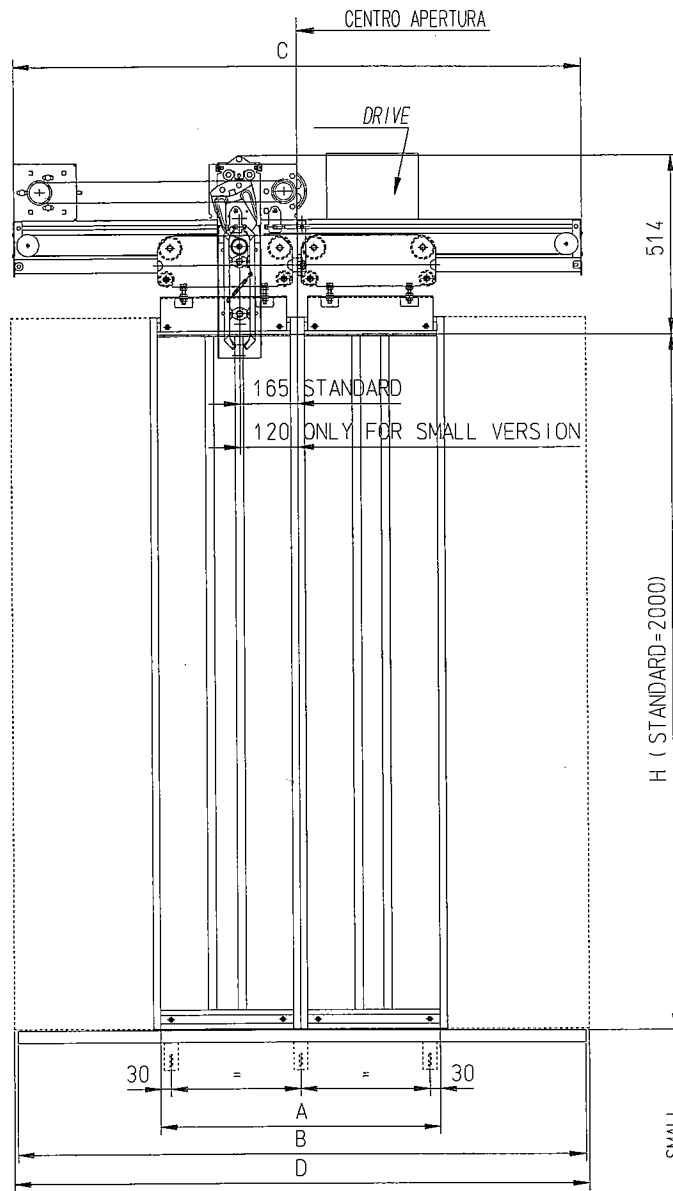
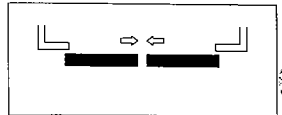

SMALL

* = WITH EXTRATRAVEL + 20MM

"A" =	"B" =	*"C" =	*"D" =
500	1040	1030	1040
550	1140	1080	1140
600	1240	1230	1240
650	1340	1280	1340
700	1440	1420	1440
750	1540	1470	1540
800	1640	1620	1640
850	1740	1670	1740
900	1840	1820	1840
950	1940	1870	1940
1000	2040	2020	2040
1050	2140	2070	2140
1100	2240	2220	2240

PAGE 3 - 5

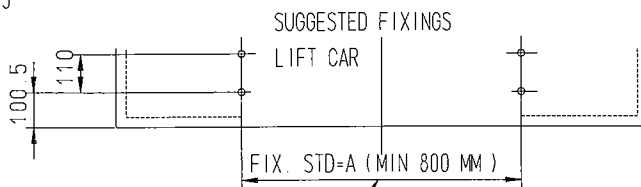

FOR SPECIAL FIXING < 800 MM
PLEASE CONTACT OUR TECHNICAL DEPARTMENT.

CAR DOORS

C1S - C2C

05/2003 - D0002 ML

LINEAR D.O.S. MINI SILL

SEMI-AUTOMATIC

OVERALL DIMENSIONS

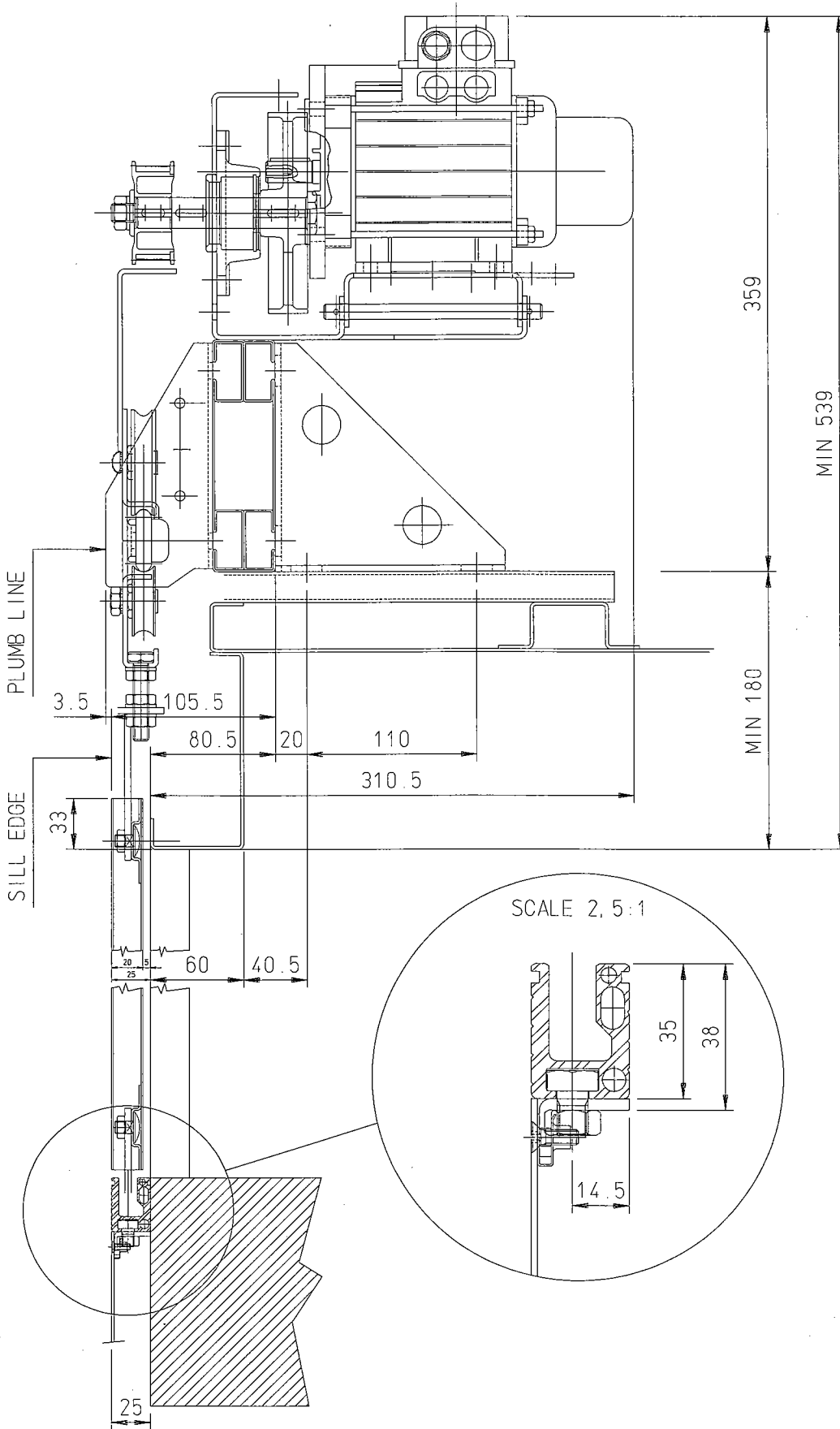

CAR DOORS

LINEAR D.O.S. MINI SILL PLUS

C1S - C2C

SEMI AUTOMATIC

SILL EXTENSION IN THE C.O. AREA

05/2003 - D0002 ML

OVERALL DIMENSIONS

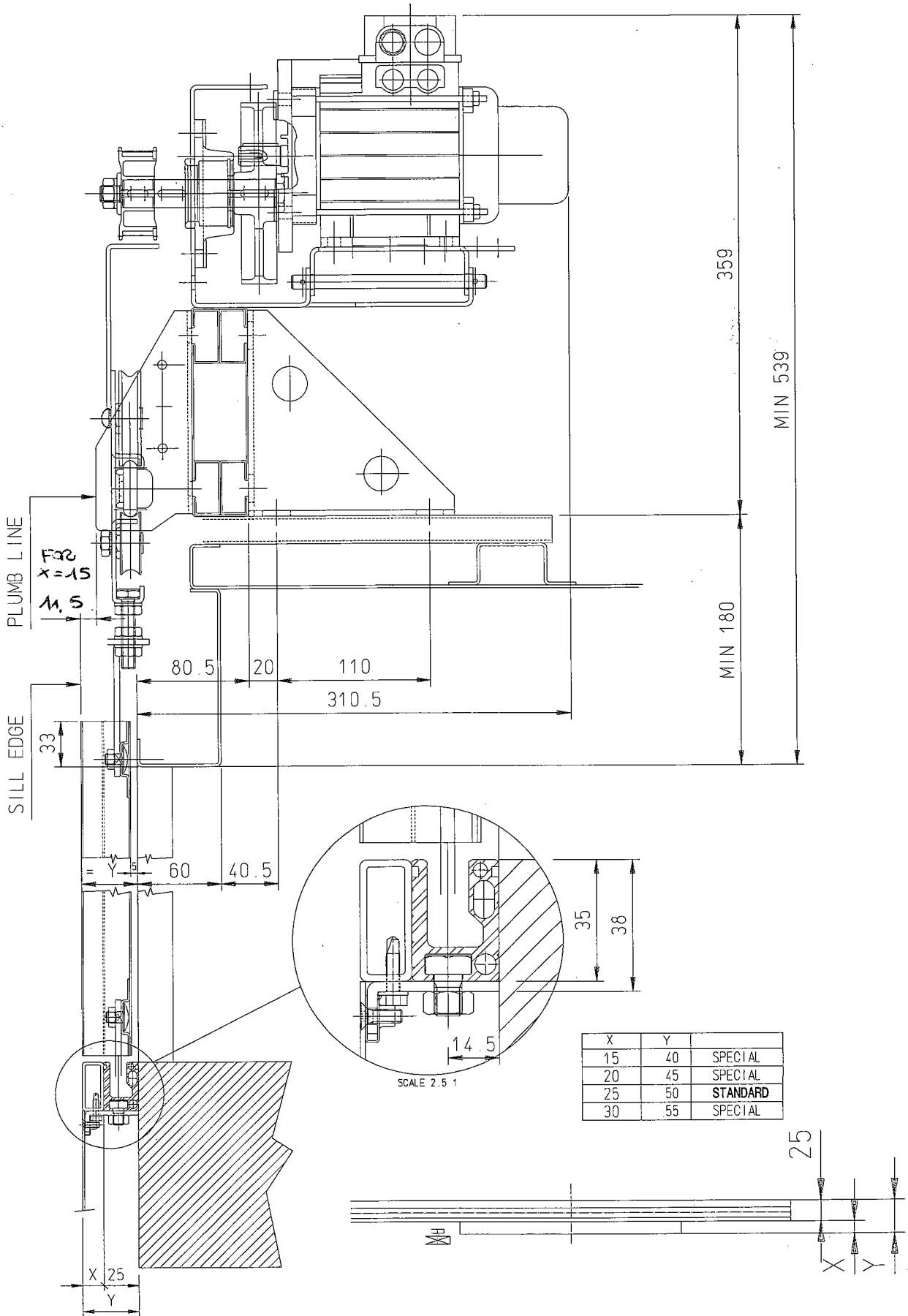

CAR DOORS

LINEAR D.O.S. MINI SILL PLUS

C1S - C2C

AUTOMATICO SILL EXTENSION IN THE C.O. AREA

05/2003 - D0002 ML

OVERALL DIMENSIONS

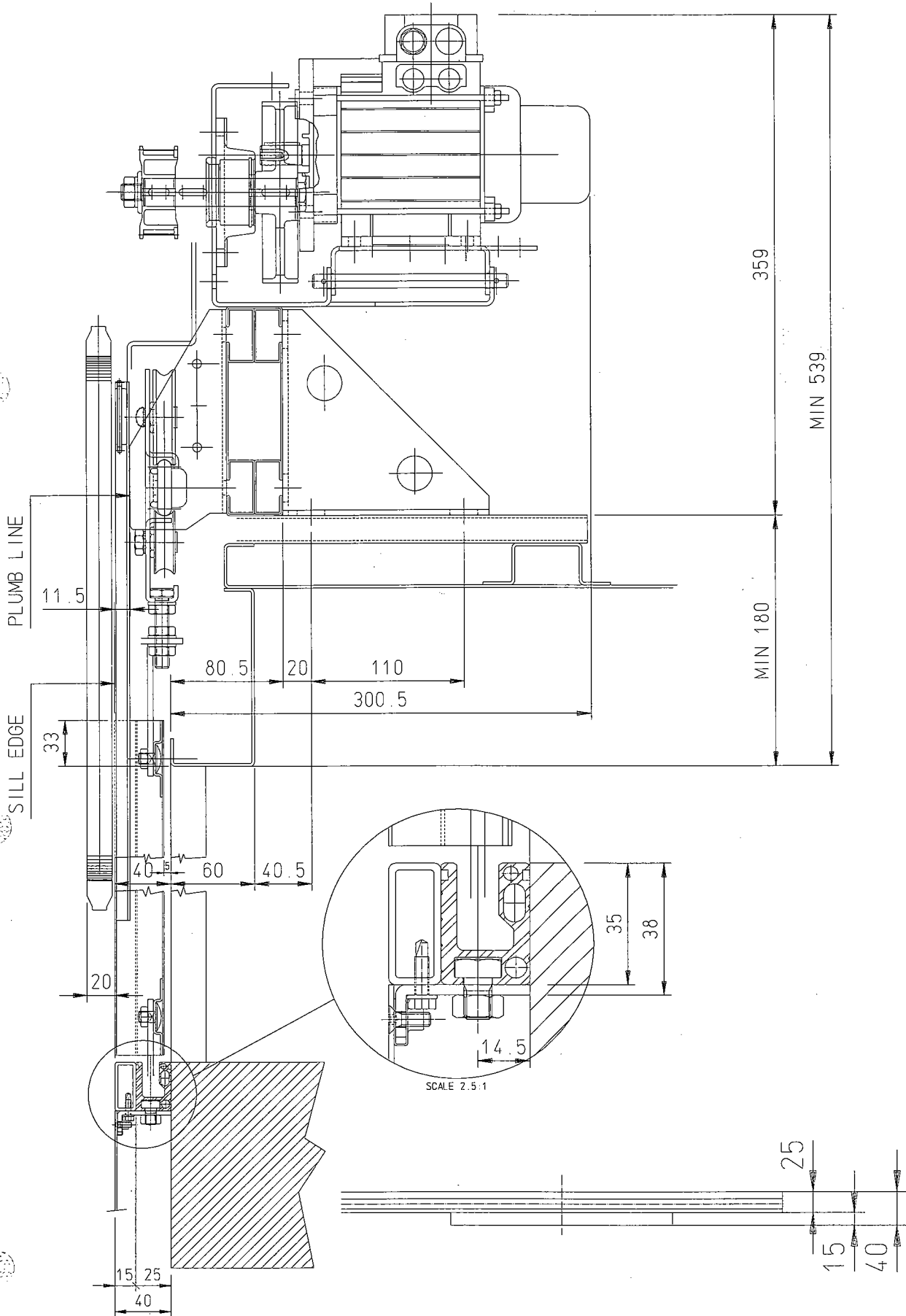

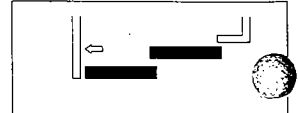

C2S

05/2003 - D0002.ML

OVERALL DIMENSIONS

DOOR L	A DISEGNO
DOOR R	OPPOSITE HAND

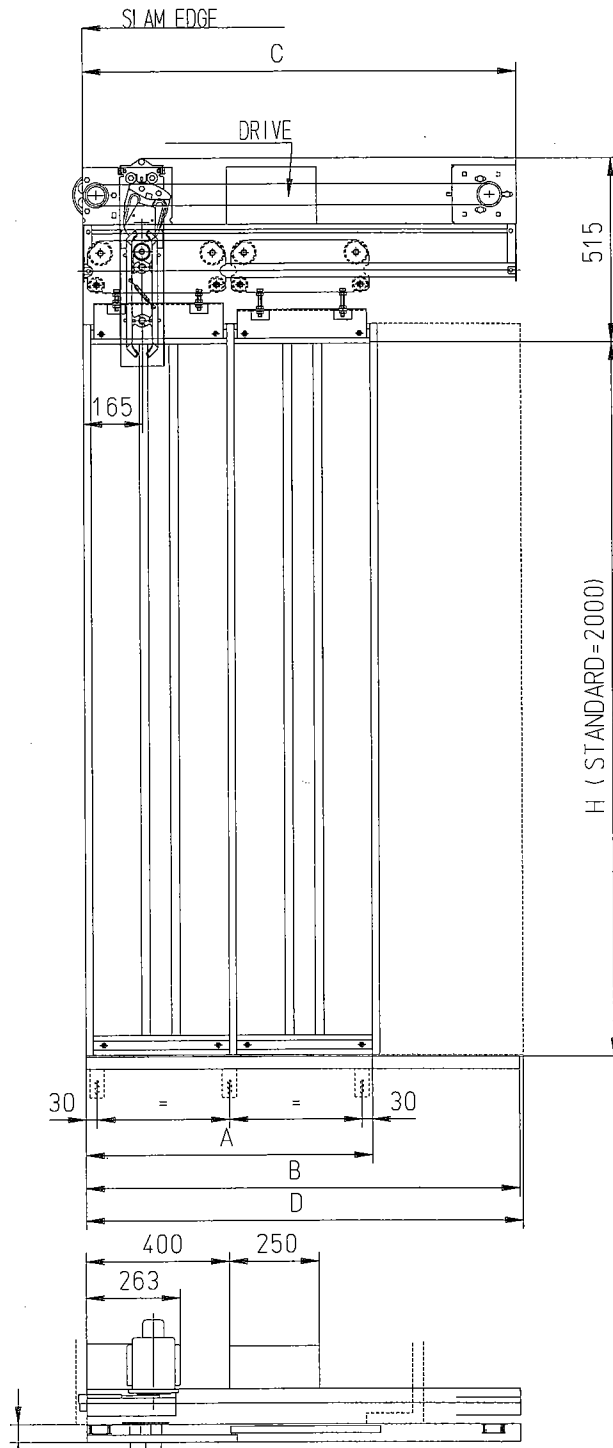

* = WITH EXTRATRAVEL DI 25MM

A=	B=	C=	D=	*D=
700	1070	1060	1070	1080
750	1145	1110	1145	1155
800	1220	1210	1220	1230
850	1295	1260	1295	1305
900	1370	1360	1370	1380
950	1445	1410	1445	1455
1000	1520	1510	1520	1530
1050	1595	1560	1595	1605
1100	1670	1660	1670	1680



PAGE 08 - 10

SUGGESTED FIXINGS

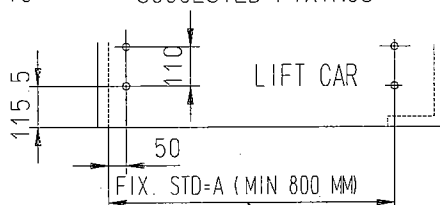

FOR SPECIAL FIXING. < 800 MM

PLEASE CONTACT OUR TECHNICAL DEPARTMENT.

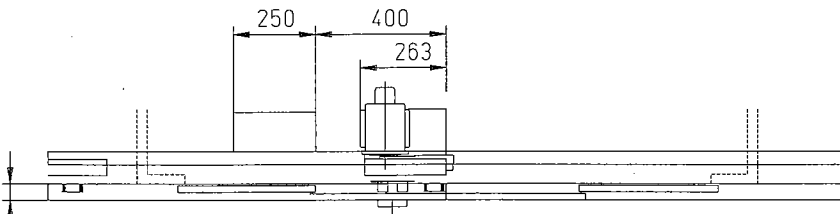
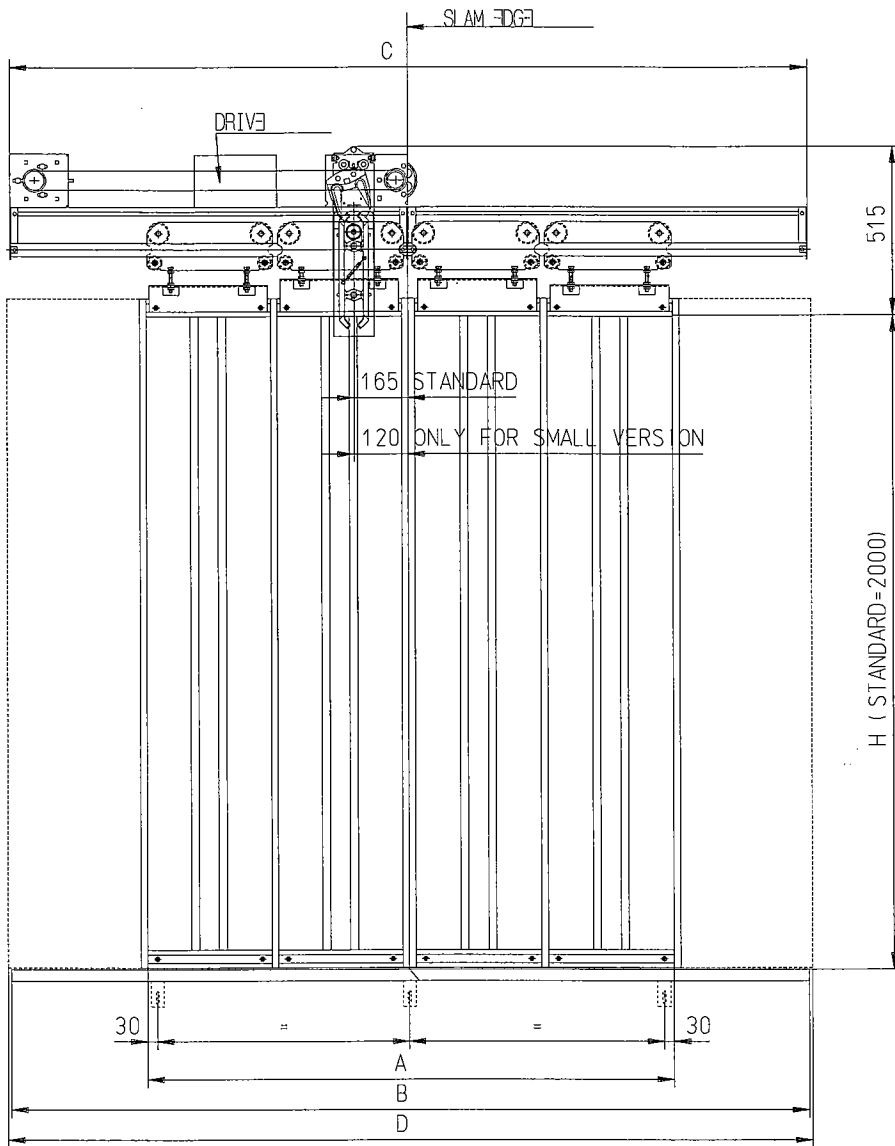

PAGE 08 - 10

SUGGESTED FIXINGS

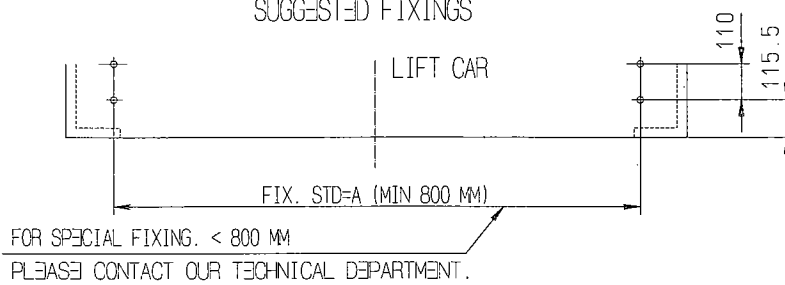

SMALL
 *= WITH EXTRATRAVEL + 20MM
 ONLY AVAILABLE WITH SILL EXTENSION

A=	B=	*C=	*D=
600	1040	1030	1040
650	1090	1080	1090
700	1140	1130	1140
750	1190	1180	1190
800	1240	1230	1240
850	1315	1280	1315
900	1390	1380	1390
950	1465	1430	1465
1000	1540	1530	1540
1050	1615	1580	1615
1100	1690	1630	1690
1150	1765	1680	1765
1200	1840	1830	1840
1250	1915	1880	1915
1300	1990	1930	1990

CAR DOORS
C2S - C4C

LINEAR D.O.S. MINI SILL
SEMI AUTOMATIC

05/2003 - D0002 ML

OVERALL DIMENSIONS

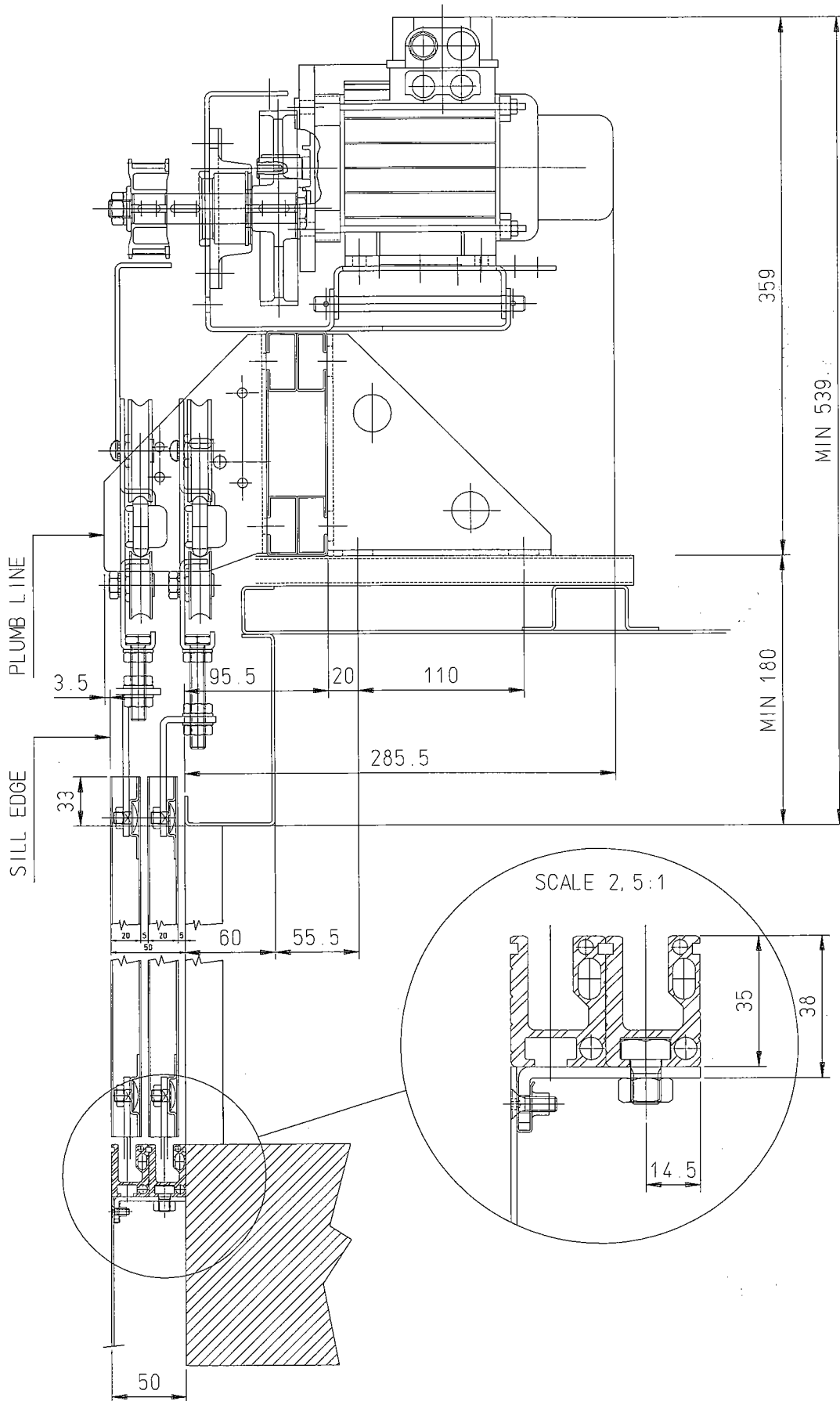

CAR DOORS

LINEAR D.O.S. MINI SILL PLUS

C2S - C4C

SEMI AUTOMATIC

SILL EXTENSION IN THE C.O. AREA

05/2003 - D0002 ML

OVERALL DIMENSIONS

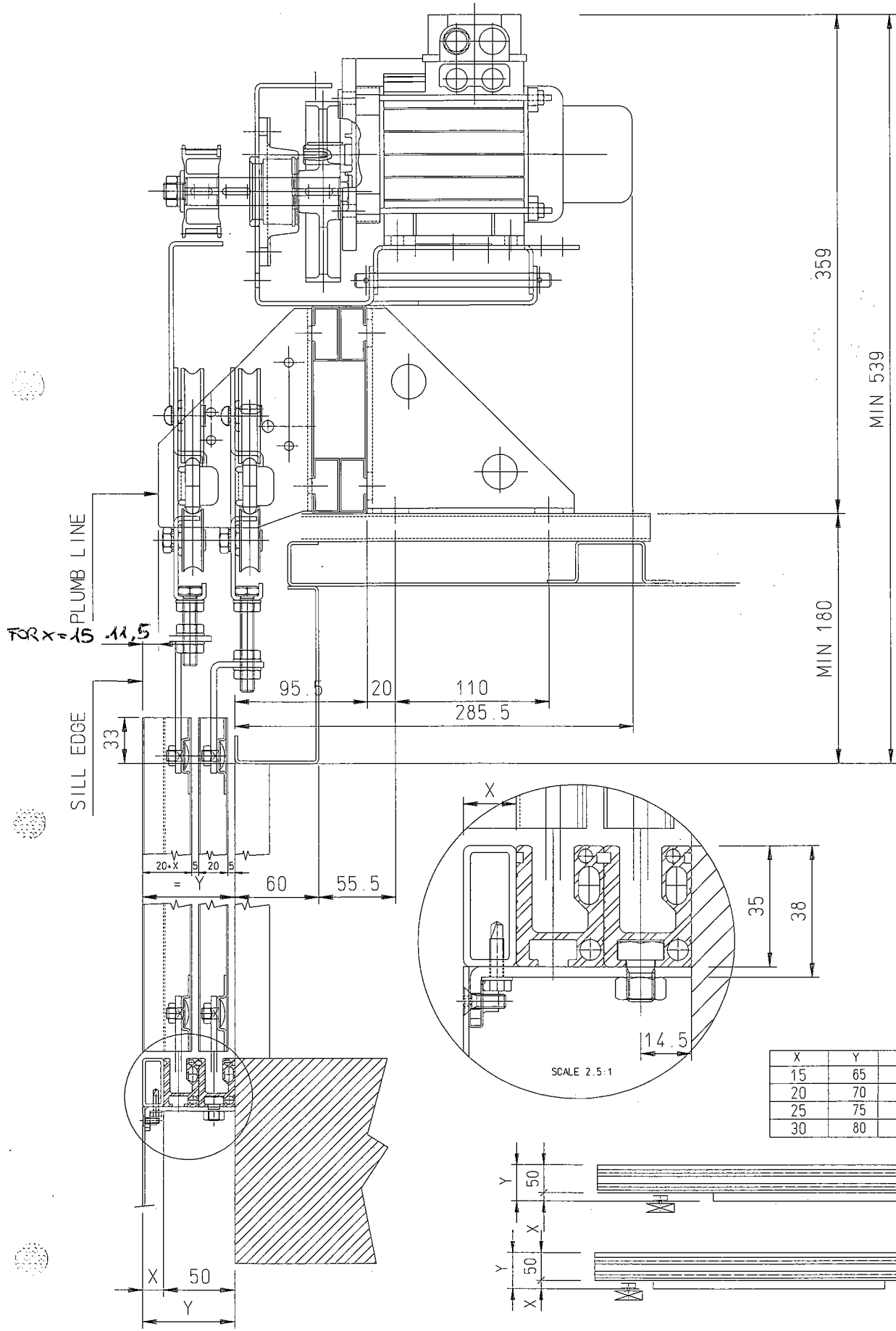

X	Y	
15	65	SPECIAL
20	70	SPECIAL
25	75	STANDARD
30	80	SPECIAL

CAR DOORS

C2S - C4C

05/2003 - D0002 ML

LINEAR D.O.S. MINI SILL

AUTOMATICO SILL EXTENSION IN THE C.O. AREA

OVERALL DIMENSIONS

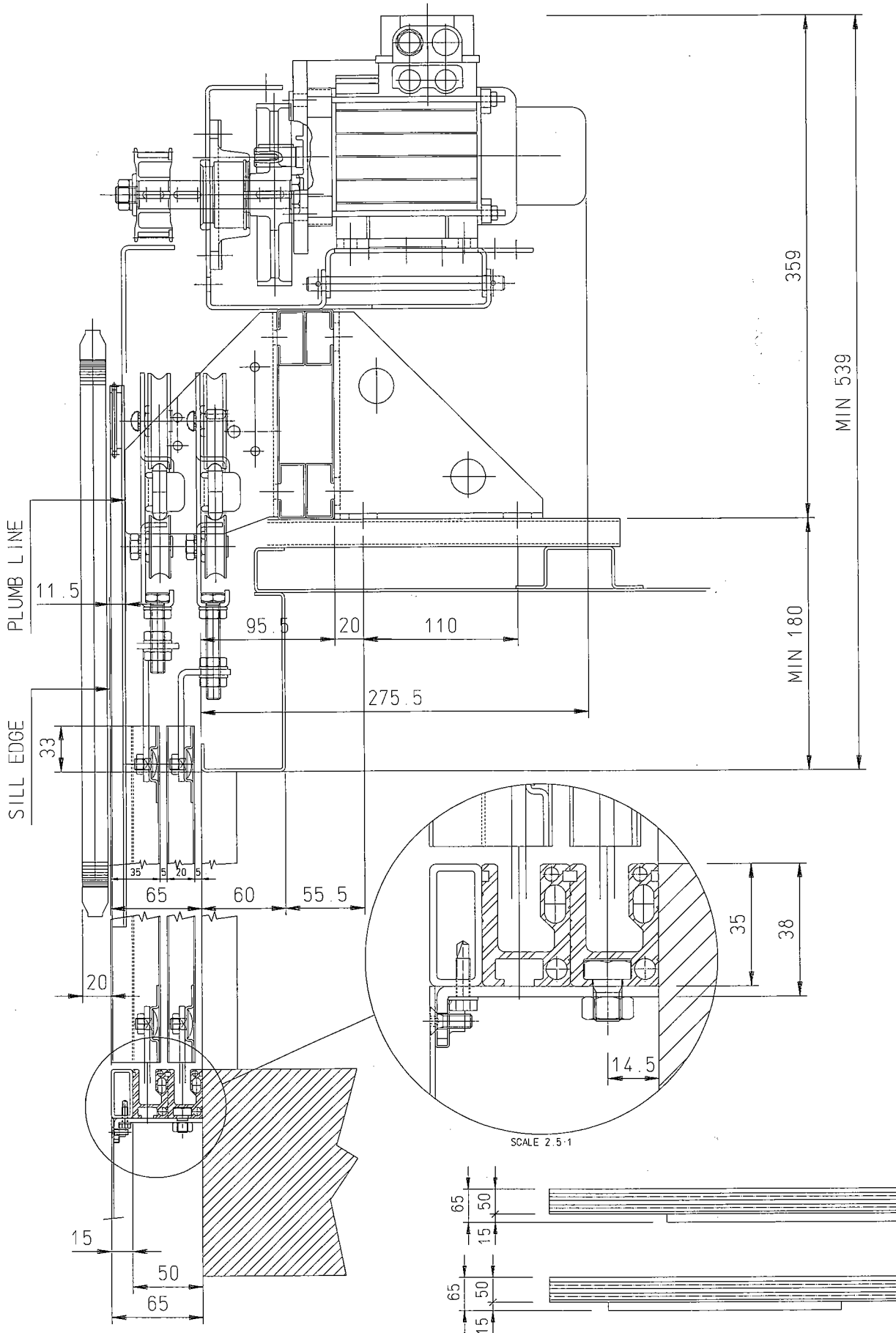

CAR DOORS

LINEAR D.O.S.

EXECUTION

MINI SILL

05/2003 - D0002 ML

OVERALL DIMENSIONS



C3S

DOOR L	A DISEGNO
DOOR R	OPPOSITE HAND

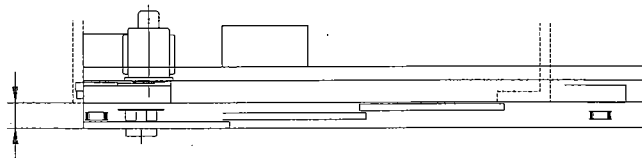
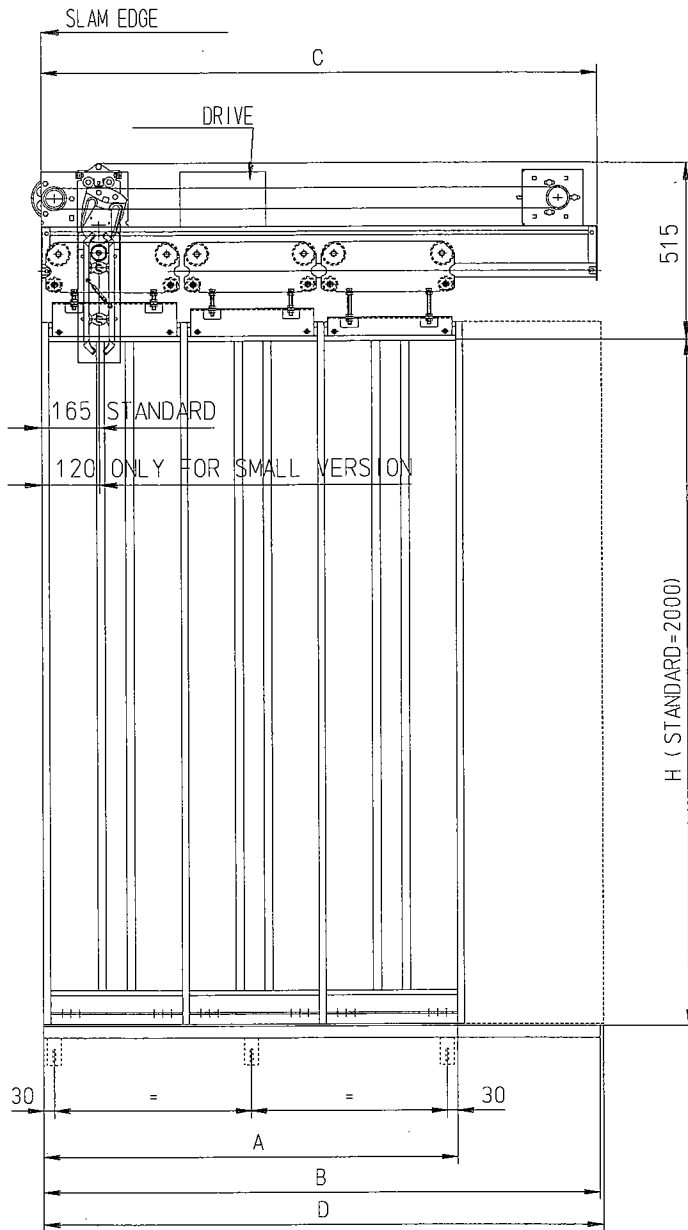

PAGE 12 - 14

SUGGESTED FIXINGS

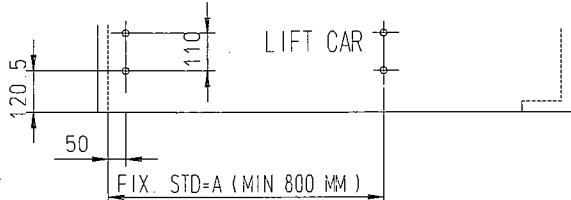

FOR SPECIAL FIXING < 800 MM
PLEASE CONTACT OUR TECHNICAL DEPARTMENT.

* = WITH EXTRATRAVEL DI 25MM

A=	B=	C=	D=	*D=
800	1085	1091	1085	1095
850	1155	1115	1155	1165
900	1220	1215	1220	1230
950	1285	1265	1285	1295
1000	1350	1315	1350	1360
1050	1420	1410	1420	1430
1100	1485	1460	1485	1495
1150	1550	1510	1550	1560
1200	1620	1610	1620	1630

CAR DOORS

C3S - C6C

05/2003 - D0002 ML

LINEAR D.O.S. MINI SILL

SEMI AUTOMATIC

OVERALL DIMENSIONS

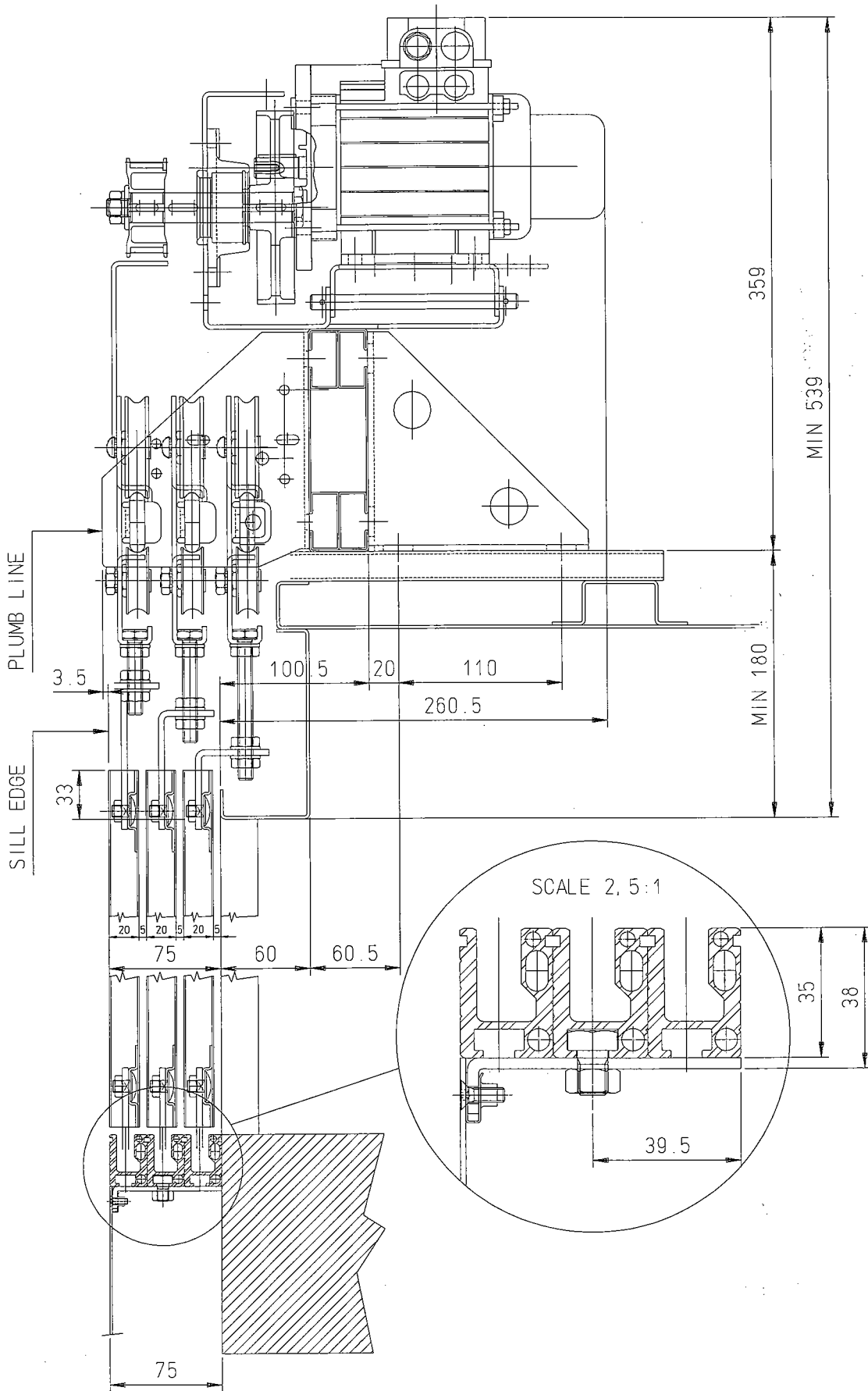

CAR DOORS

C3S - C6C

05/2003 - D0002 ML

LINEAR D.O.S. MINI SILL PLUS

AUTOMATICO SILL EXTENSION IN THE C.O. AREA

OVERALL DIMENSIONS

